

ENCLOSURES

Cleancabs, extraction hoods and accessories

PUREX
CLEAN AIR FOR EVERYONE

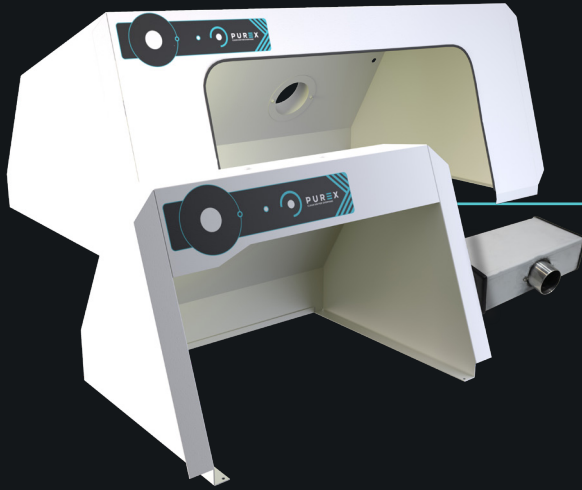

Description & features

- Enclosing the source, enabling fumes to be captured before they can contaminate
- Customisable extraction hoods available
- Protection from fumes created by soldering, adhesives and more
- Quick setup and easy to relocate

Specification

Voltage	840182 Delta	840160 Clear Hood	120703 Black Cowl	120704 Clear Cowl	840116 650 Clear Hood	840105 Small PURCAB	840106 Large PURCAB
Enclosure Height	22mm	175mm	130mm	130mm	140mm	290mm	402mm
Enclosure Width	200mm	310mm	450mm	450mm	420mm	461mm	1001mm
Enclosure Depth	125mm	265mm	224mm	224mm	320mm	301mm	601mm
Enclosure Weight	2kg	1kg	2kg	2kg	1kg	5kg	10kg

Clean Cabs

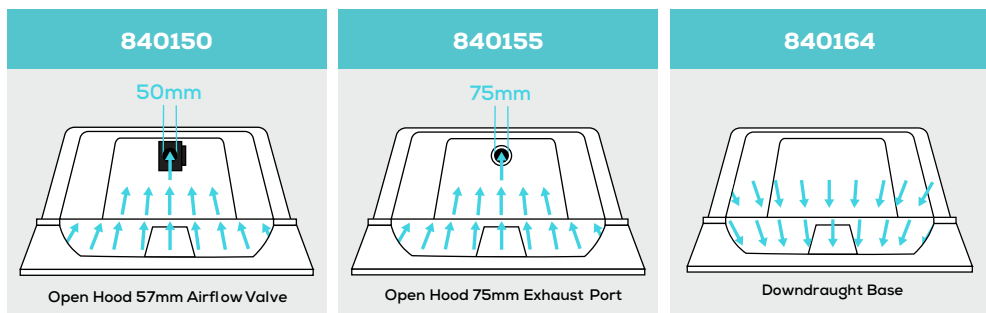

Creating a larger, more secure capture area by joining your process to a Purex cleancab enclosure ideal for those soldering electronics keeping a contained work environment. For more information on the Purex CleanCab please contact Purex.

Cowls

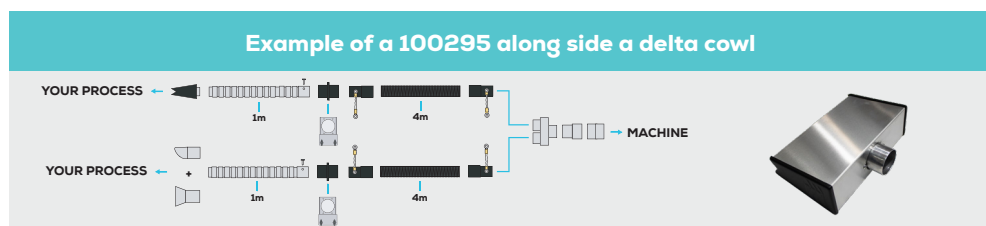

Designed to capture fumes horizontally across a workbench to keep fumes away from workers breathing zones. For more information on the Delta Cowl please contact Purex

Find out more: W purex.co.uk | [T +44 \(0\)1405 746030](tel:+44(0)1405746030) | [E purex@purex.co.uk](mailto:purex@purex.co.uk)

Registered Office: Purex International Limited, QWP House, Island Drive, Capitol Park, Thorne, Doncaster DN8 5UE
Registered No. 5136616 England | VAT No. GB842 5025 49 | WEEE Producer Registration Number: WEE/CE0067TX
*Goods are subject to change | *Illustrations are 3D created visual representations

ENCLOSURES

Compact, multi-use fume extraction unit

Options

Clear Hoods Cowl

Clear Hood Connection kit | 100299

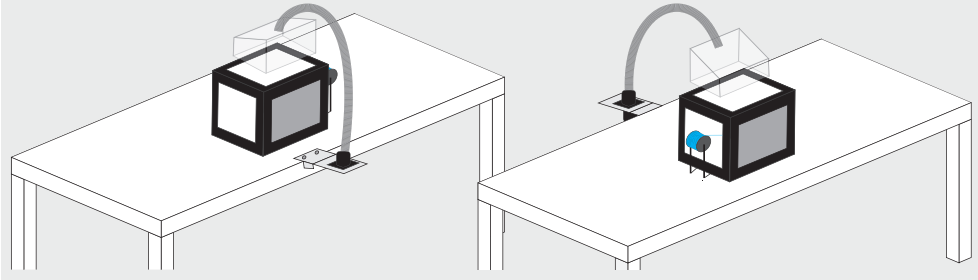

Designed to capture and contain hazardous airborne substances at the source. For more information on the Clear Hoods please contact Purex

Plenum Cowl

Clear: 120704 | Black: 120703

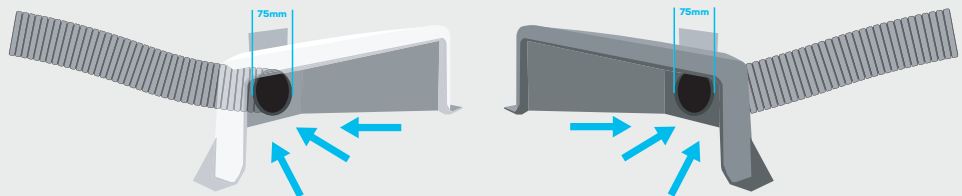

Designed to capture fumes horizontally across the workbench to keep fumes away from the workers. For more information on the Plenum Cowls please contact Purex

PURCAB

Small PURCAB | 840105

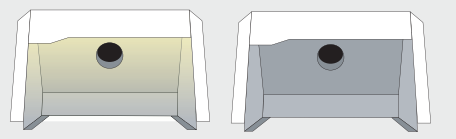

Large PURCAB 840106

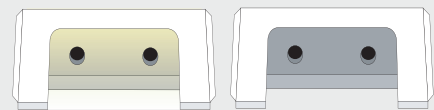

Creating a larger, more secure capture area by joining your process to a Purex PURCAB enclosure, ideal for those soldering electronics keeping a contained work environment. For more information on the Purex PURCAB please contact Purex