

CONNECTION KITS

Please contact Purex for additional support

PUREX
CLEAN AIR FOR EVERYONE

50mm Purex Inlet

120117

Diameter of Customers port or pipework	Hose Length	Purex Machine Inlet Diameter
50mm	2.0m	50mm

2.0m

1 x 2m x 51mm flexible hose (570249)
2 x 51mm cuffs (570203)

120115

Diameter of Customers port or pipework	Hose Length	Purex Machine Inlet Diameter
50mm	3.0m	50mm

3.0m

1 x 3m x 51mm flexihose (570249)
2 x 51mm flexible hose cuffs (570203)

100037

Diameter of Customers port or pipework	Hose Length
50mm	6m (Extension)

6.0m

1 x 50mm coupling black (520330)
1 x 6m x 51mm flexible hose (570249)
2 x 51mm cuffs (570203)

80mm Purex Inlet

100119

Diameter of Customers port or pipework	Purex Machine Inlet Diameter
9mm	80mm

YOUR PROCESS ← — → **MACHINE**

1 x 32mm straight pipe connector (500060)
1 x 32mm pipe plug access (500120)
1 x aluminium reducer 80mm - 34mm (550283)
1 x 12mm Adaptor hose (580035)

100170

Diameter of Customers port or pipework	Hose Length	Purex Machine Inlet Diameter
32mm	1.5m	80mm

1.5m

2 x half straight connector (500061)
1 x aluminium reducer 80mm - 34mm (550283)
1 x 1.5m x 41mm flexible hose (570040)
2 x 35mm to 50mm hose clips (580620)

100026

Diameter of Customers port or pipework	Hose Length	Purex Machine Inlet Diameter
50mm	3.0m	80mm

3.0m

1 x earth strap 6mm (105054)
1 x 80mm to 51 reducer (550287)
1 x 3m x 50mm antistatic hose (570042)
2 x 51mm antistatic cuffs (570211)
1 x Pan head screw (700316)
1 x M4 shakeproof washer (730310)

STD: 100043 | PVC: 100043C

Diameter of Customers port or pipework	Hose Length	Purex Machine Inlet Diameter
50mm	6.0m	80mm

6.0m

1 x 80-51mm reducer (550287)
1 x 6m x 51mm flexible hose (570249)
1 x Flexible hose cuff black (570203)
2 x 51mm PVC cuffs (120113)

***Coated reducers suitable for PVC applications (550287C)**

Find out more: W purex.co.uk | [T +44 \(0\)1405 746030](tel:+44(0)1405746030) | [E purex@purex.co.uk](mailto:purex@purex.co.uk)

Registered Office: Purex International Limited, OWP House, Island Drive, Capitol Park, Thorne, Doncaster DNB 5UE
Registered No. 5136618 England | VAT No. GB842 5025 49 | WEEE Producer Registration Number: WEE/CE0067TX

*Goods are subject to change

CONNECTION KITS

Please contact Purex for additional support

PUREX
CLEAN AIR FOR EVERYONE

100039

Diameter of Customers port or pipework	Hose Length	Purex Machine Inlet Diameter
50mm	6m (Dual Manifold)	80mm

Use along side a 100043 / 100043C

YOUR PROCESS ← ← MACHINE

6.0m

- 1 x dual manifold assembly (120093C)
- 2 x 6m x 51mm flexible hose (570249)
- 2 x 51mm cuffs (570203)

Suitable for PVC applications (120113)

100180

Diameter of Customers port or pipework	Hose Length	Purex Machine Inlet Diameter
50mm	2.0m	80mm

YOUR PROCESS ← ← MACHINE

2.0m

- 1 x 80-53.5mm reducer (550280)
- 1 x 2m x 77mm flexible hose (570050)
- 2 x 45mm to 60mm hose clips (580630)

STD: 100032 | PVC: 100032C

Diameter of Customers port or pipework	Hose Length	Purex Machine Inlet Diameter
50mm	3.0m	80mm

YOUR PROCESS ← ← MACHINE

3.0m

- 1 x 80mm to 51mm reducer (550287)
- 1 x 51mm cuffs (570203)
- 1 x 3m x 51mm black flexihose (570249)
- 1 x PVC cuffs (120113)

*Coated reducers suitable for PVC applications (550287C)

100019

Diameter of Customers port or pipework	Hose Length	Purex Machine Inlet Diameter
50mm	3.0m	80mm

YOUR PROCESS ← ← MACHINE

2.0m

- 1 x 50mm to 57mm connection kit (120117)
- 1 x Reducer aluminium (550287)

120285

Diameter of Customers port or pipework	Hose Length	Purex Machine Inlet Diameter
50mm	3.0m	80mm

YOUR PROCESS ← ← MACHINE

3.0m

- 1 x Reducer 80mm to 53mm (550280)
- 1 x 3m x 57mm flexible hose (570050)
- 2 x 45mm to 60mm hose clips (580630)

100183

Diameter of Customers port or pipework	Hose Length	Purex Machine Inlet Diameter
75mm	1.5m	80mm

YOUR PROCESS ← ← MACHINE

1.5m

- 1x 75mm - 75mm x 1.5m connection kit (100185)
- 1x Clean cab - open hoode 75mm port (840155)

100185

Diameter of Customers port or pipework	Hose Length	Purex Machine Inlet Diameter
75mm	1.5m	80mm

YOUR PROCESS ← ← MACHINE

1.5m

- 2 x 85-75mm reducer (840113)
- 1 x 1.5m x 75mm flexible hose (570305)

120327

Diameter of Customers port or pipework	Hose Length	Purex Machine Inlet Diameter
76mm	1.0m	80mm

YOUR PROCESS ← ← MACHINE

1m

- 1x Aluminium reducer 80mm - 63mm (550293)
- 1 x 1m x 76mm flexihose (570305)
- 1x Hose cuff 63mm (570205)
- 2x Hose clip 70-90 (580650)

Find out more: W purex.co.uk | [T +44 \(0\)1405 746030](tel:+44(0)1405746030) | [E purex@purex.co.uk](mailto:purex@purex.co.uk)

Registered Office: Purex International Limited, QWP House, Island Drive, Capitol Park, Thorne, Doncaster DN8 5UE
Registered No. 5136616 England | VAT No. GB842 5025 49 | WEEE Producer Registration Number: WEE/CE0067X
*Goods are subject to change

CONNECTION KITS

Please contact Purex for additional support

PUREX
CLEAN AIR FOR EVERYONE

120262

Diameter of Customers port or pipework	Hose Length	Purex Machine Inlet Diameter
80mm	2.0m	80mm

YOUR PROCESS ←  ← MACHINE

2m

- 1x 80mm coupling (540025)
- 1x 2m x 80mm flexihose (570053)
- 2x Hose clip 70 - 90mm (580650)

120293

Diameter of Customers port or pipework	Hose Length	Purex Machine Inlet Diameter
80mm	1.3m	80mm

YOUR PROCESS ←  ← MACHINE

1.3m

- 1 x 80mm female coupling (540025)
- 2 x 70 - 90mm hose clips (580650)
- 1 x 1.3m x 82mm flexible hose (570053)

120350

Diameter of Customers port or pipework	Hose Length	Purex Machine Inlet Diameter
80mm	0.8m	80mm

YOUR PROCESS ←  ← MACHINE

0.8m

- 1 x 0.8m x 84mm flexihose (570053)
- 2x Hose clip 70mm - 90mm (580650)

120304

Diameter of Customers port or pipework	Hose Length	Purex Machine Inlet Diameter
80mm	6.0m	80mm

YOUR PROCESS ←  ← MACHINE

6m

- 1x 80mm coupling (540025)
- 1 x 6m x 84mm flexihose (570053)
- 2 x Hose clips 70mm - 90mm (580650)

120299

Diameter of Customers port or pipework	Hose Length	Purex Machine Inlet Diameter
80mm	3.0m	80mm

YOUR PROCESS ←  ← MACHINE

3.0m

- 1 x 80mm female coupling (540025)
- 1 x 3m x 82mm flexible hose (570053)
- 2 x 70-90mm hose clips (580650)

120258

Diameter of Customers port or pipework	Hose Length	Purex Machine Inlet Diameter
100mm	4.0m	80mm

YOUR PROCESS ←  ← MACHINE

4m

- 1x 100mm coupling (540120)
- 1 x Reducer 100mm - 80mm (540150)
- 2 x Hose clip 70mm - 90mm (580650)
- 1 x 4m x 84mm flexihose (570053)
- 1 x 80mm coupling (540025)

120326

Diameter of Customers port or pipework	Hose Length	Purex Machine Inlet Diameter
100mm	1.8	80mm

YOUR PROCESS →  ← MACHINE

0.3m

1.5m

← YOUR PROCESS

- 1x 80mm coupling (540025)
- 1x 100mm coupling (540120)
- 1x Equal tee 100 (540145)
- 1x Reducer 100mm - 80mm (540150)
- 1 x 1.5m x 80mm flexihose (570053)
- 2 x 2x 0.3m x 100mm flexihose (570060)
- 2x Hose clip 70mm - 90mm (580650)
- 4x Hose clip 90mm - 120mm (580660)

120297

Diameter of Customers port or pipework	Hose Length	Purex Machine Inlet Diameter
100mm	2m (Dual)	80mm

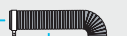
YOUR PROCESS ←  ← MACHINE

2.0m

- 3 x 80mm coupling (540025)
- 1 x 80mm equal tee (540070)
- 2 x 2m x 100mm flexible hose (421255)
- 4 x 90-120mm hose clips (580660)

Find out more: W purex.co.uk | [T +44 \(0\)1405 746030](tel:+44(0)1405746030) | [E purex@purex.co.uk](mailto:purex@purex.co.uk)

Registered Office: Purex International Limited, QWP House, Island Drive, Capitol Park, Thorne, Doncaster DN8 5UE
Registered No. 5136616 England | VAT No. GB842 5025 49 | WEEE Producer Registration Number: WEE/CE00677X

*Goods are subject to change

CONNECTION KITS

Please contact Purex for additional support

PUREX
CLEAN AIR FOR EVERYONE

120328

Diameter of Customers port or pipework	Hose Length	Purex Machine Inlet Diameter
100mm	2.6m	80mm

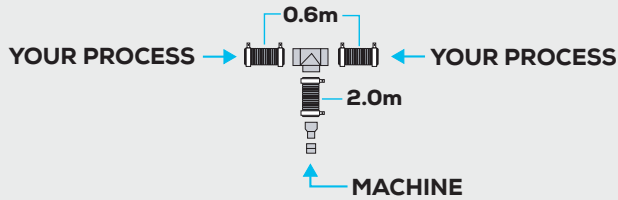

- 1x 80mm coupling (540025)
- 1x 100mm coupling (540120)
- 1x Equal tee 100mm (540145)
- 1x Reducer 100mm - 80mm (540150)
- 1 x 2x 0.6m & 1x 2m x 100mm flexihose (570060)
- 6x Hose clip 90mm - 120mm (580660)

120292

Diameter of Customers port or pipework	Hose Length	Purex Machine Inlet Diameter
100mm	1.3m	80mm

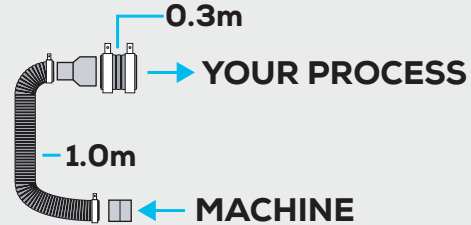

- 1 x 80mm female coupling (540025)
- 1 x 100mm to 80mm reducer (540150)
- 1 x 1m x 82mm flexible hose (570053)
- 2 x 70mm - 90mm hose clips (580650)
- 0.3m x 100mm flexible hose (570060)
- 2 x 90mm - 120mm hose clips (580660)

120288

Diameter of Customers port or pipework	Hose Length	Purex Machine Inlet Diameter
100mm	2.3m	80mm

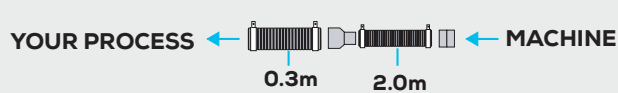

- 1 x 80mm female coupling (540025)
- 1 x 100mm to 80mm reducer (540150)
- 1 x 2m x 82mm flexible hose (570053)
- 1 x 0.3m x 100mm flexible hose (570060)
- 2 x 70-90mm hose clips (580650)
- 2 x 90-120mm hose clips (580660)

100171

Diameter of Customers port or pipework	Hose Length	Purex Machine Inlet Diameter
125mm	3.0m	80mm

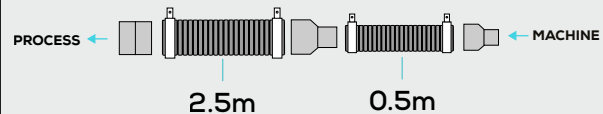

- 1 x 100mm to 80mm reducer (540150)
- 1 x 2.5m x 100mm flexible hose (570060)
- 1 x 125mm to 100mm reducer (540280)
- 1 x 125mm female coupling (540270)
- 2 x 70mm to 90mm hose clips (580650)
- 2 x 90mm to 120mm hose clips (580660)

120289

Diameter of Customers port or pipework	Hose Length	Purex Machine Inlet Diameter
150mm	3.3m	80mm

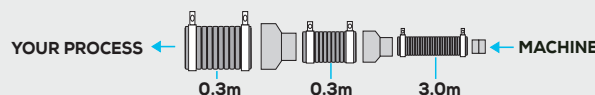

- 1 x 80mm female coupling (540025)
- 1 x 100mm - 80mm reducer (540150)
- 1 x 150mm - 100mm reducer (540382)
- 1 x 3m x 82mm flexible hose (570053)
- 1 x 0.6m x 150mm flexible hose (570070)
- 2 x 70 - 90mm hose clips (580650)
- 1 x 0.3 x 100mm flexible hose (570060)
- 2 x 90 - 120mm hose clips (580660)
- 2 x 135 - 160mm hose clips (580670)

Find out more: W purex.co.uk | [T +44 \(0\)1405 746030](tel:+44(0)1405746030) | [E purex@purex.co.uk](mailto:purex@purex.co.uk)

Registered Office: Purex International Limited, QWP House, Island Drive, Capitol Park, Thorne, Doncaster DN8 5UE
Registered No. 5136616 England | VAT No. GB842 5025 49 | WEEE Producer Registration Number: WEE/CE0067X
*Goods are subject to change

CONNECTION KITS

Please contact Purex for additional support

PUREX
CLEAN AIR FOR EVERYONE

100mm Purex Inlet

100186

Diameter of Customers port or pipework	Hose Length	Purex Machine Inlet Diameter
100mm	1.0m	100mm

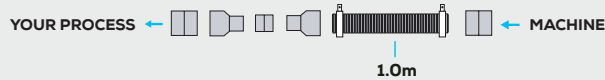

- 1 x 80mm coupling (540025)
- 2 x 100mm coupling (540120)
- 2 x Reducer 100mm - 80mm (540150)
- 1 x 1m 100mm flexihose (570060)
- 2 x Hose clip 90mm - 120mm (580660)

120291

Diameter of Customers port or pipework	Hose Length	Purex Machine Inlet Diameter
100mm	3m (Dual)	100mm

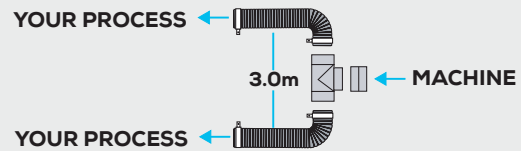

- 1 x 100mm female coupling (540120)
- 1 x 100mm equal tee (540145)
- 2 x 3m x 102mm flexible hose (570060)
- 4 x 90-120mm hose clips (580660)

120354

Diameter of Customers port or pipework	Hose Length	Purex Machine Inlet Diameter
100mm	0.5m	100mm

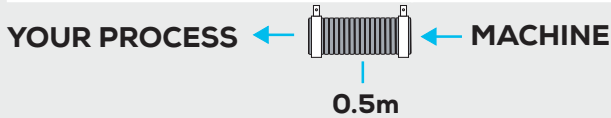

- 1 x 0.5m x 100mm flexihose (570060)
- 2 x Hose clip 90mm - 120mm (580660)

120270

Diameter of Customers port or pipework	Hose Length	Purex Machine Inlet Diameter
100mm	1.5m	100mm



- 1 x 100 female coupling (540120)
- 1 x 1.5m x 100mm flexible hose (570060)
- 2 x 90mm to 120mm hose clips (580660)

120360

Diameter of Customers port or pipework	Hose Length	Purex Machine Inlet Diameter
100mm	1.0m	100mm

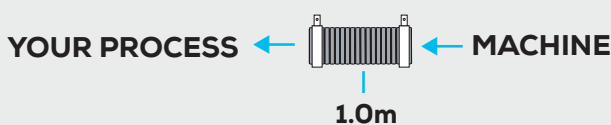

- 1 x 1m x 100mm flexihose (570060)
- 2 x Hose clip 90mm - 120mm (580660)

100186

Diameter of Customers port or pipework	Hose Length	Purex Machine Inlet Diameter
100mm	1.0m	100mm

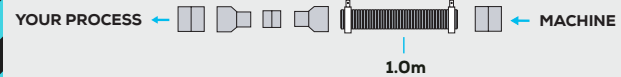

- 1 x 80mm coupling (540025)
- 2 x 100mm coupling (540120)
- 2 x Reducer 100mm - 80mm (540150)
- 2 x 90-120mm hose clip (580660)
- 1 x 1m x 84mm flexihose (570053)

100107*

Diameter of Customers port or pipework	Hose Length	Purex Machine Inlet Diameter
100mm	3.0m	100mm

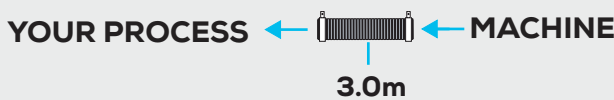

- 1 x 3m x 100mm flexible hose (570060)
- 2x 90mm to 120mm hose clips (580660)

*Suitable for PVC applications

100184

Diameter of Customers port or pipework	Hose Length	Purex Machine Inlet Diameter
100mm	1.0m	100mm

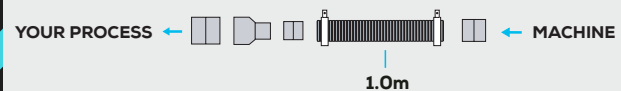

- 1 x 80mm coupling (540025)
- 1 x 100mm coupling (540120)
- 1 x Reducer 100mm - 80mm (540150)
- 2 x 70mm - 90mm hose clip (580650)
- 1 x 1m x 100mm flexihose (570060)

Find out more: W purex.co.uk | [T +44 \(0\)1405 746030](tel:+44(0)1405746030) | [E purex@purex.co.uk](mailto:purex@purex.co.uk)

Registered Office: Purex International Limited, OWP House, Island Drive, Capitol Park, Thorne, Doncaster DN8 5UE
Registered No. 5136616 England | VAT No. GB842 5025 49 | WEEE Producer Registration Number: WEE/CE0067X
*Goods are subject to change

CONNECTION KITS

Please contact Purex for additional support

PUREX
CLEAN AIR FOR EVERYONE

100172

Diameter of Customers port or pipework	Hose Length	Purex Machine Inlet Diameter
125mm	1.5m	100mm

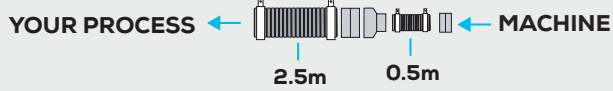

- 1 x Reducer 125mm to 100mm (540280)
- 1 x 2.5m x 125mm flexihose grey (570069)
- 2 x 135mm - 165mm hose clips (580670)
- 1 x 0.5m x 100mm flexihose (570060)
- 2 x 90mm - 120mm hose clip (580660)

120294

Diameter of Customers port or pipework	Hose Length	Purex Machine Inlet Diameter
150mm	3.25m	100mm

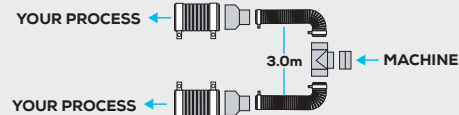

- 1 x 100mm female coupling (540120)
- 1 x 100mm equal tee (540145)
- 4 x 90 - 120mm hose clips (580660)
- 2 x 3m x 100mm flexible hose (570060)
- 2 x 150mm - 100mm reducer (540382)
- 2 x 0.25m x 150mm flexible hose (570070)
- 4 x 135 - 165mm hose clips (580670)

120320

Diameter of Customers port or pipework	Hose Length	Purex Machine Inlet Diameter
150mm	3.25m	100mm



- 1x 100mm coupling (540120)
- 1x Reducer 150mm - 100mm (540382)
- 1x 100mm flexihose (570060)
- 1x 152mm flexihose
- 2x Hose clip 90mm - 120mm (580660)
- 2x Hose clip 135mm - 165mm (580670)

120340

Diameter of Customers port or pipework	Hose Length	Purex Machine Inlet Diameter
150mm	6.2m	100mm

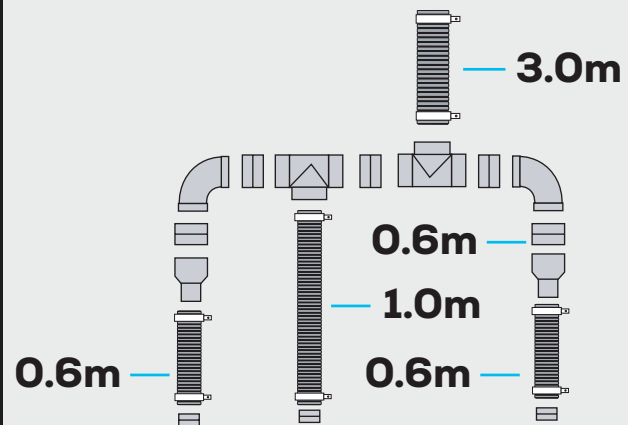

- 1 x Equal tee 150mm (540337)
- 5 x 150mm coupling (540320)
- 2 x 150mm 90° bend (540345)
- 1 x Equal tee 100mm (540336)
- 3 x 100mm coupling (540120)
- 1 x 3m x 152mm flexihose (570070)
- 1 x 3.2 100mm flexihose (570060)
- 6x Hose clip 90mm - 120mm (580660)
- 2x Hose clip 135mm - 165mm (580670)
- 2x Reducer 150mm - 100mm (540382)

125mm Purex Inlet

120300

Diameter of Customers port or pipework	Hose Length	Purex Machine Inlet Diameter
125mm	3m	125mm

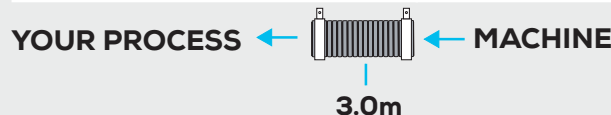

- 1 x 3m x 125mm flexible hose (570069)
- 2 x 125-165mm hose clips (580670)

Find out more: W purex.co.uk | [T +44 \(0\)1405 746030](tel:+441405746030) | [E purex@purex.co.uk](mailto:purex@purex.co.uk)

Registered Office: Purex International Limited, OWP House, Island Drive, Capitol Park, Thorne, Doncaster DN8 5UE
Registered No. 5136616 England | VAT No. GB842 5025 49 | WEEE Producer Registration Number: WEE/CE0067TX
*Goods are subject to change

CONNECTION KITS

Please contact Purex for additional support

PUREX
CLEAN AIR FOR EVERYONE

150mm Purex Inlet

120287

Diameter of Customers port or pipework	Hose Length	Purex Machine Inlet Diameter
100mm	3m (Dual)	150mm

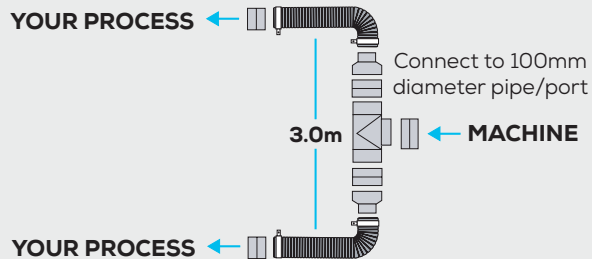

- ← YOUR PROCESS
- 2 x 100mm female coupling (540120)
 - 1 x 150mm equal tee (540337)
 - 2 x 150 to 100mm reducers (540382)
 - 2 x 3m x 102mm flexible hose (570060)
 - 4 x 90mm to 120mm hose clips (580660)
 - 3 x 150mm female couplings (540320)

120280

Diameter of Customers port or pipework	Hose Length	Purex Machine Inlet Diameter
150mm	1.5m	150mm

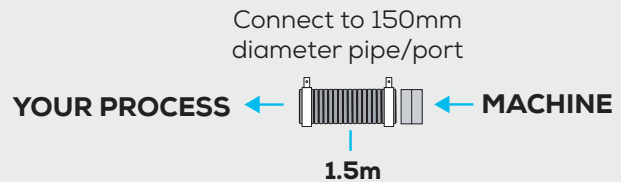

- 1 x 150mm female coupling (540320)
- 1 x 1.5m x 150mm flexible hose (570070)
- 2 x 135mm to 160mm hose clips (580670)

200mm Purex Inlet

120296

Diameter of Customers port or pipework	Hose Length	Purex Machine Inlet Diameter
200mm	1.0m	200mm

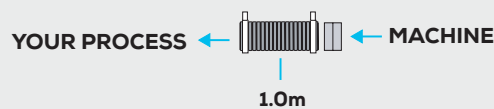

- 1 x 200mm female coupling (540701)
- 1 x 1m x 200mm flexible hose (570071)
- 4 x 90-120mm hose clips (580660)

Find out more: W purex.co.uk | [T +44 \(0\)1405 746030](tel:+44(0)1405746030) | [E purex@purex.co.uk](mailto:purex@purex.co.uk)

Registered Office: Purex International Limited, QWP House, Island Drive, Capitol Park, Thorne, Doncaster DN8 5UE
Registered No. 5136616 England | VAT No. GB842 5025 49 | WEEE Producer Registration Number: WEE/CE0067TX
*Goods are subject to change

SOLDERING KITS

Please contact Purex for additional support

PUREX
CLEAN AIR FOR EVERYONE

100085

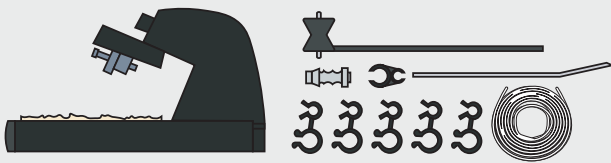

- 1 x 1.5m x Silicone wall (560030)
- 1 x Adaptor hose (580010)
- 5 x Swivel clip assembly (580525)
- 1 x Universal soldering iron stand (830007)
- 1 x Rubber clip universal solder tip (830051)
- 1 x Extraction tube (830135)

300001

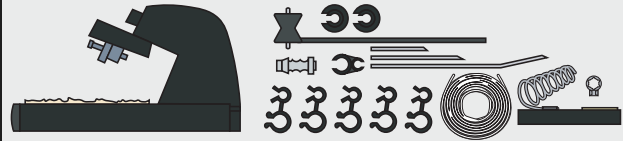

- 1 x 1.5m x Silicone wall (560030)
- 1 x Adaptor hose (580010)
- 5 x Swivel clip assembly (580525)
- 1 x Universal soldering iron stand (830007)
- 1 x Rubber clip universal solder tip (830051)
- 1 x Extraction tube (830135)
- 1 x Extraction tube - weller iron (830110)
- 1 x Extraction tube - metcal iron (830112)

300002

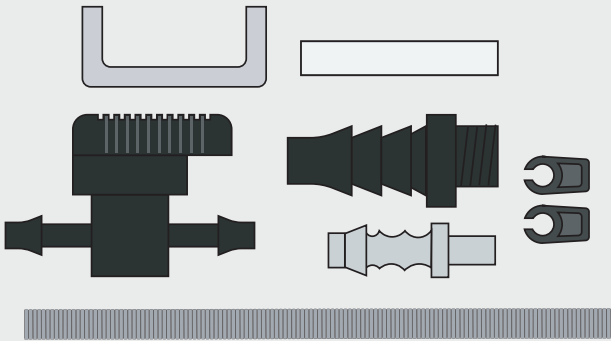

- 1 x 0.4m x Silicone wall (560030)
- 1 x 1m x 13mm hose - vsm grey (570000)
- 1 x Adaptor hose (580035)
- 1 x Bracket for ON/OFF tap (580090)
- 1 x Connector hose stem (580210)
- 2 x Hose clip 15mm (580500)
- 1 x ON/OFF tap black (590078)

300002

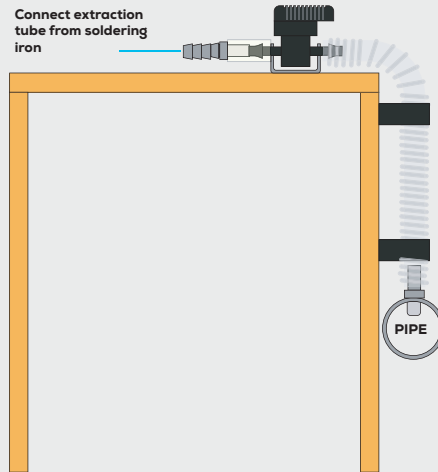

100100

Connect extraction tube from soldering iron

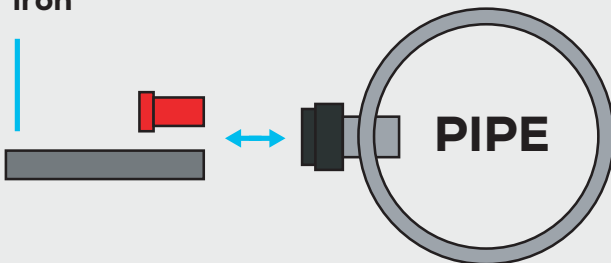

- 1 x Adaptor hose (580070)
- 1 x Blanked red plate (580130)
- 1 x Adaptor hose (580300)

100090

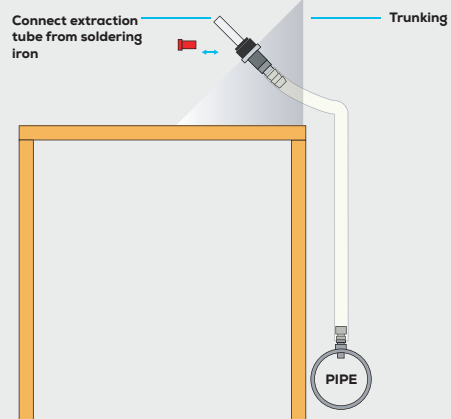

- 1 x 1.0m x Silicone wall (560030)
- 1 x Blanked red plate (580130)
- 1 x Connector Hose bulkhead (580190)
- 1 x Connect hose stem (580210)
- 1 x Adaptor hose (560030)
- 1 x Adaptor hose (580300)

Find out more: W purex.co.uk | [T +44 \(0\)1405 746030](tel:+44(0)1405746030) | [E purex@purex.co.uk](mailto:purex@purex.co.uk)

Registered Office: Purex International Limited, QWP House, Island Drive, Capitol Park, Thorne, Doncaster DN8 5UE
Registered No. 5136616 England | VAT No. GB842 5025 49 | WEEE Producer Registration Number: WEE/CE0067TX
*Goods are subject to change